

Notes:

165 mm Hifi woofer,
metal powdered paper
cone and dustcap,
rubber edge,
terminals:

“+” 4.8 x 0.8 mm
“-” 2.8 x 0.8 mm

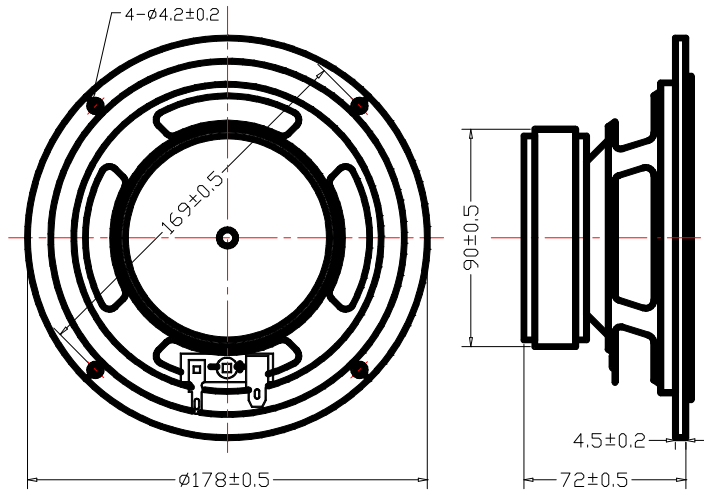

impedance:	8 Ω
nom. power:	60 watts
SPL 1W/1m:	88 dB
fs:	50 Hz
Re:	6.9 Ω
Le:	0.66 mH
Qms:	2.7
Qes:	0.7
Qts:	0.5
VAS :	21 l
Mms :	12 g
Rms :	1.6 kg/s
Cms:	0.8 mm/N
B*I:	6.1 Tm
Sd:	135 cm ²
Xmax:	+/-3 mm
weight:	1.0 kg
magnet:	13 oz
voice coil Ø:	25 mm

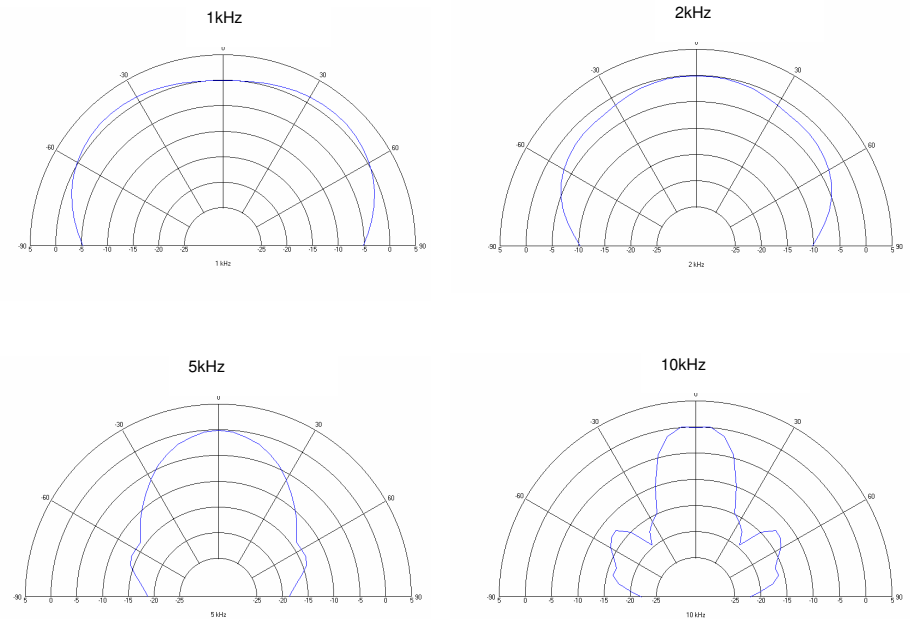

TECHNICAL DATA ARE MEASURED WITH ATB – EQUIPMENT ACCORDING EN – 60268 –5.

FOR PRODUCT IMPROVEMENT HKM RESERVES ALTERATIONS IN SPECIFICATIONS AND DESIGN WITHOUT FURTHER ANNOUNCEMENT

FOR TOLERANCES OF TECHNICAL DATA REFER TO HKM 'S MANUAL OF TECHNICAL DATA

FOR INFORMATION CONTACT: TEL.: +49 9073 / 9585 0, FAX.: +49 9073 / 9585 55, E-MAIL: INFO@HKM-GROUP.DE